



Installation Instructions

Engineered Hardwood Plywood Flooring

Visit eaglecreekfloors.com for latest version of installation instructions.

Products Included	Approved Grade Levels	Approved Installation Methods
All Engineered Hardwood Plywood Tongue and Groove	On Grade. Above Grade. Below Grade	Nail/Cleat/Staple or Full Spread Glue. Residential Only: Floating with Joint Glue

CALIFORNIA RESIDENTS

⚠ WARNING: This product can expose you to formaldehyde gas which is known to the State of California to cause cancer. For more information, go to www.P65Warnings.ca.gov.

⚠ WARNING: Drilling, sawing, sanding or machining wood products can expose you to wood dust, a substance known to the State of California to cause cancer. Avoid inhaling wood dust or use a dust mask or other safeguards for personal protection. For more information go to www.P65Warnings.ca.gov/wood.

CAUTION: ASBESTOS IN EXISTING FLOOR

Home Legend product does not contain asbestos. Existing installed resilient flooring and asphaltic adhesive may contain **asbestos fillers or crystalline silica**. Do not sand, dry sweep, dry scrape, drill, saw, bead-blast, or mechanically chip or pulverize existing resilient flooring, backing, lining felt, asphaltic “cutback” adhesive or other adhesive. See “Recommended Work Practices for Removal of Resilient Floor Coverings” (rfci.com) for detailed information and instructions on removing all resilient covering structures.

Owner/Installer Responsibility

The owner is advised to be at home during the installation for consultation/direction. The owner and installer should discuss installation and layout to maximize satisfaction. If this is not possible, consultation should be done prior to installation. Installers should be familiar with installation guidelines from National Wood Flooring Association (woodfloors.org).

The owner/installer assumes all responsibility for product quality of completed installation.

PERFORM PRE-INSTALL INSPECTION. FOR CLAIMS PURPOSES, YOU ARE ALLOWED TO OPEN UP TO 4 BOXES FOR PRODUCT INSPECTION. DO NOT OPEN ALL THE BOXES. OPENING ALL THE BOXES CONSTITUTES YOUR ACCEPTANCE OF THE PRODUCT. INSPECT ALL THE PLANKS IN THESE 4 BOXES CAREFULLY. EXAMINE FLOORING FOR COLOR, FINISH AND QUALITY. IF YOU DISCOVER THAT PRODUCTS ARE DEFECTIVE, OR IF MATERIAL IS QUESTIONABLE, YOU SHOULD CONTACT THE RETAILER. IF YOU ARE SATISFIED, PROCEED WITH INSTALLATION.

The length of each plank in any box can vary from 12 inches to the maximum full length stated on the packaging or other product descriptions. Each box can contain all full-length boards or a combination of full length and shorter boards. There is no specific percentage of product length distribution.

Prior to installation, rack up planks from several boxes to ensure uniform distribution of colors, shades and characters in the installed flooring. Planks having similar widths should be placed together in the same row to minimize gaps between boards.

Hardwood floors are natural products containing natural variations. Variations in color, tone, grain, mineral streaks, small knots and other characters are found from plank to plank. Similar variations exist between samples, pictures and purchased flooring. They are normal and it does not mean the product is defective.

Flooring to be installed in one large area should be purchased at the same time. Product purchased at a later time than the first purchase may vary beyond your expectations.

Accessories, trims and moldings are manufactured to coordinate with the varied appearances of the floor planks. Any exact matches are coincidental. Non-matching accessories are not defective products.

This product is manufactured according to strict quality standards. In the event that defects are discovered in the field, the industry standards permit a defect tolerance not to exceed 5%. The defects may be of any type, whether manufactured or natural. Order an additional 5% extra for cutting wastage and grading allowances (10% for diagonal installations).

During installation, inspect the planks continuously. Defects that can be seen from a standing position should be cut off or the plank held out. Installing defective planks implies acceptance.

Squeaking and clicking noises are the result of interactions among flooring, joists and subfloors when they move. Limiting the movements of the flooring system usually eliminates most of these noises. Sometimes, it is impossible to eliminate them completely and minor squeaking or clicking noises are to be accepted as normal flooring phenomenon. Minor scratches can generally be repaired with the use of putty, stain or filler. It is an industry standard practice of flooring installation and it should be accepted as normal by the home owner.

If You Need More Information

To assure the warranty is not inadvertently voided, before proceeding with any activity that is not covered in this manual, please contact our Technical Support Department.

Acclimation and In-service Conditions		
<p>Acclimation is the process of adjusting (conditioning) the moisture content of hardwood flooring to the environment in which it is expected to perform. The hardwood flooring is fully acclimated when its moisture content and dimensions (width and length) are stable. For example, the averaged dimensions and moisture content remain constant for 3 consecutive days. Flooring must acclimate for as long as necessary to reach fully acclimated stage. Acclimation time varies depending on geographical area, interior climate control and time of the year. Minimum acclimation time is 2 days.</p> <p>This product must be acclimated with the box and plastic wrap, if any, cut open. Elevate planks from the floor by placing them on 2"X 2" lumber or equivalence. Place spacers (3/4" to 1" sticks) between each layer or cross stack the layers for maximum exposure to ambient conditions. Acclimation temperature range is 60°F-80°F and relative humidity (RH) of 35%-55%. Conditions in which the floor was acclimated should be maintained continuously thereafter. Document as much acclimation information as possible below.</p>		
Date: _____	Pre-acclimation Flooring Avg. Moisture Content (%): _____	Post-acclimation Flooring Avg. Moisture Content (%): _____
Relative Humidity (%): _____	Pre-acclimation Flooring Width: _____	Post-acclimation Flooring Width: _____
Temperature (°F): _____	Pre-acclimation Flooring Length: _____	Post-acclimation Flooring Length: _____
Subfloor Type: _____		
Subfloor Avg. Moisture Content (%): _____		
Acclimation Period: _____		

Job Site Condition

Prior to installation, the installer must ensure that at the time of installation, the job site conditions including subfloor/substrate, ambient temperature, relative humidity, and all impacting variables will not negatively affect floor. Home Legend will decline responsibility for damages associated with improper installation or poor site conditions.

Storage and Conditions

Do not store flooring under uncontrolled environmental conditions. For example, garages and exterior patios are not acceptable areas to store flooring. Handle and unload hardwood flooring with care and store within the environmentally controlled site in which it is expected to perform. Flooring stored on concrete slab should be elevated at least four inches to allow air circulation under cartons.

Existing Home

Existing home should have a consistent room temperature of 60°F-80°F and relative humidity (RH) of 35%-55%. Continual deviation from these conditions will affect the dimensions of hardwood flooring. During heating season, humidity may be much lower than the acceptable range. During the heating season, a humidifier is recommended to prevent excess shrinkage in hardwood flooring due to low humidity levels. During the non-heating season, humidity levels can be maintained by using an air conditioner, dehumidifier, or by turning on your heating system periodically during the summer months.

New Construction or Remodel

All work involving water, such as pouring basement concrete floors, drywall and plasterwork, plumbing, etc. must be completed well in advance of the floor delivery. Ensure that the building is enclosed. Where building codes allow, permanent heating and/or air conditioning systems should be operating at least five days preceding installation to promote proper acclimation and should be maintained during and after installation. If it is not possible for the permanent heating and/or air conditioning system to be operating before, during and after installation, a temporary heating and/or dehumidification system that simulate normal living (occupied) conditions can enable the installation to proceed until the permanent heating and/or air conditioning system is fully operational.

Your job site should have a consistent temperature of 60°F-80°F and relative humidity (RH) of 35%-55% that should be maintained continuously thereafter.

Basements and Crawl Spaces

Concrete slab or ground must be dry. The ground in the crawl spaces must be completely covered using 6 mil black polyethylene. Crawl space clearance between the earth and underside of joists should be no less than 18 inches and the perimeter vent area should be equal to 1.5% of the total square footage of the crawl space or as mandated by code.

Concrete Subfloor Requirements

It must have minimum rated strength of 3000 psi.

It must be level to within 1/8" in 6 feet span or 3/16" in a 10-foot span; no bumps or low spots. High spots can be removed by grinding; depressions can be filled with patching compound formulated for use in floor installation.

It must be clean; no construction debris, soil, mud and any other objects on/or adhering to the floor; if necessary, scrape and sweep away before the installation; no protrusions of nails, debris, metals should remain.

New concrete slab must cure for at least 60 days. It must have a minimum 10 mil polyethylene sheet between the ground and the concrete. It must meet concrete moisture requirement below.

It must be free from moisture related conditions which can damage the installed flooring.

Light Weight Concrete

It is concrete which rated strength is less than 3000 psi.

Perform a quick check by drawing a nail across the top; if it leaves indentation, it is probably light concrete.

For glue-down application, the concrete must possess shear strength greater than the glue. If concrete rated psi is unknown, contact the adhesive manufacturer for guidance.

Concrete Moisture

All concrete subfloors should be tested for moisture content and the results documented. Visual checks are not reliable. Perform tests at locations around exterior doorways, near walls containing plumbing, near foundation walls and in the center of the room. Minimum sample size is 3 samples per 1000 square feet of area and one test for every additional 1000 square feet thereafter.

Its moisture content should meet one of the following criteria below:

- 4.5% when tested using Tramex Concrete Moisture Encounter
- Less than 3 pounds per 1000 square feet per 24 hours when using Calcium Chloride test (ASTM F 1869)
- 75% when using Relative Humidity Testing (ASTM F-2170).

Please note: Concrete moisture content may be acceptable the time of the test. These tests do not guarantee a perpetual “dry” concrete slab. The concrete slab can be wet at other times of the year. We are not responsible for moisture related damage to installed flooring.

Wood Subfloor Requirements

It must be clean; no presence of construction debris, soil, mud and any other objects on or adhering to the floor; no protrusions of nails, debris, metals should remain. If necessary, scrape and sweep the subfloor before the installation.

It must be structurally sound and stable: no movements or squeaks; no loose panels or loose nails; no signs of ply de-lamination or other damages. Repair all shortcomings before installation.

It must be flat with no visible bumps or low spots; the subfloor should be flat to within 1/8” in 6 feet span or 3/16” in 10 feet.

Test for moisture using reliable moisture meter. Perform tests at locations around exterior doorways, near foundation walls, near walls containing plumbing lines and in the center of the room. Measure 20 locations per 1000 square feet.

Moisture content of subfloor should be less than 12%.

Moisture content difference between subfloor and acclimated flooring should be 4% or less.

Plywood or Oriented Strand Board (OSB) Specifications

On truss/joist spacing of 16” (406mm) O/C or less, the industry standard for single-panel subflooring is minimum 5/8” (19/32”, 15.1 mm) CD Exposure 1 plywood subfloor panels (CD Exposure 1) or 23/32” OSB Exposure 1 subfloor panels, 4’ x 8’ sheets. Expansion gap between panels should be 1/8” (3 mm). If panels are not tongued and grooved and there is not sufficient spacing or is inadequate, cut in the required spacing with a circular saw. Do not cut in expansion space on tongue and groove panels.

Particle Board or Fiber Board

Only for floating installation.

Existing Floors

Installation over existing floor requires the installer to consider potential issues related to moisture damage, adhesive failure and fastener failure. Contact the adhesive and fastener manufacturers respectively for their specific instructions, recommendations and requirements.

Acceptable floor coverings include: solid hardwood, linoleum, terrazzo, ceramic tile and other “moisture sealing floors.”

Unacceptable floor coverings include: carpet, needle punch felt, edge glued linoleum and other “moisture absorbing flooring.”

Radiant Heated Subfloor

This product can be installed over radiant heated subfloor. The heating element must be embedded or installed below the subfloor. The heating element must be embedded or installed below the subfloor. Operating floor surface temperature must be less than 84°F. Decrease temperature before installation. Increase temperature gradually after installation. Glue down installation may require additional installation requirement. Contact glue manufacturer for specific recommendation.

Moisture Barrier and Moisture Retarder

Concrete Subfloor: For floating installation, use 6 mil polyethylene film or other means with equivalent permeability. Overlap the edge seams and tape it together. Extend moisture barrier up to the wall about 1 inch high. When installed on above grade concrete and the concrete moisture content meets concrete moisture standards, a moisture barrier is not required. For direct glue installation, follow glue manufacturer instruction for type of glue to use if moisture level exceeds requirement (see Concrete Moisture section).

Wood Subfloor: Use asphalt-saturated kraft paper or #15 or #30 felt that meets ASTM Standard D4869 or UU-B-790, Grade D.

Overlap along the edge seams 2”- 4” wide. This retards moisture movement from below. Extend the moisture retarder to about 1” from the walls. Secure to the subfloor as necessary.

Sound Control Underlayment

Check with sound control manufacturer for application guidelines. Generally, the less compressive underlayment is preferred.

Expansion Gap

Required gap width is 1/2”. It is required around the perimeter of the floor and between floor and all vertical obstructions. Do not place permanently mounted structures such as kitchen counter/cabinet on the installed floor.

Transition Molding

Floating installation, transition T-molding is required in the following cases: floor spanning greater than 35 feet in length or width; doorways or passageways 5 ft. wide or less.

Note: Floor areas interrupted by wall openings greater than 5 ft. wide or interrupted by wall sections extending out of the wall, or floor areas which are not rectangular may experience buckling or gapping if there is excessive floor expansion or shrinkage.

Adhesive

Use premium flooring adhesive which is non-water based, formulated for engineered hardwood flooring installation.

Preferred type: moisture cure urethane floor glue.

For floating installation, use edge glue formulated for engineered hardwood flooring installation.

Fastener

1/2" or thicker Floorings

Finish nail: 6d-8d.

Nail / Cleat Length: 1 1/2" to 2" (4–5 cm);

Nail size gauge: 15-16 gauge or 18-20 gauge; higher gauge is needed if tongue is splitting upon impact.

Staple length and crown size: 1 1/2" - 2" and narrow crown (3/8").

Face nailing spacing: Every 10"-12" (position first and last nail between 1"- 3" from ends and 1/2" from edge).

Blind nailing spacing: Every 6" - 8" (position first and last between 1" - 3" from ends).

3/8" Flooring

Finish nail: 6d.

Nail / Cleat Length: 1" - 1 1/2" (3-4cm);

Nail / Cleat size: 18-20 gauge. You may have to glue the floor if the tongue is splitting upon impact.

Staple length and crown size: 1" - 1 1/2" and narrow crown (3/8").

Face nailing spacing: Every 10"-12" (position first and last nail between 1"- 3" from ends and 1/2" from edge)

Blind nailing spacing: Every 6" - 8" (position first and last between 1" - 3" from ends)

Tools and Materials

Basics:

Tape measure • Moisture meter (wood, concrete or both) • Chalk line & chalk • Hammer • Power saw • Carbide tipped saw blade for fine cut • NIOSH-designated dust mask • Hand saw or jamb saw • Eye protection • Straight edge • Pry Bar • Mallet • Broom • Color matched wood putty • Tapping block • Pull bar

Additional Supplies for Nail Down or Staple Down Method:

Electric drill and bits • Compressor and hose with in-line regulator for pneumatic tools • Power nailer or stapler for flooring with height adapter to match floor thickness • Pneumatic finish nailer • Nail set

Additional Supplies for Glue Down or Floating Method:

Flooring adhesive or Joint Glue • Trowels • Adhesive remover for selected adhesive • Clean rags • Weight roller • Flooring Straps

Safety and Health Precautions

Power tools can be dangerous. Operate in strict accordance to manufacturer's operating instructions and safety precautions. Unsafe and improper use of can cause serious injuries.

Avoid inhalation and exposures to wood dust by mechanical means and by wearing personal protective equipment.

Wear appropriate personal protective equipment (PPE) which include NIOSH or OSHA approve dust masks, safety goggle and work gloves.

Floor Damage Prevention

It is extremely important to take precautionary actions to prevent damage to the floor during installation. ALWAYS TEST FIRE THE NAILER TO ENSURE PROPER SETTING. Use proper nailer, floor thickness adapters, face plates and cleats. Improper fasteners, machines and air pressure can cause severe damage to the flooring. Forcing or pounding floor boards together with a rubber mallet during assembly may bruise or damage board edges. Home Legend is not responsible for installation damages. Tongue fracture and surface dimpling are common installation damage. They are not product defects.

Damages can be minimized by one or more of the following:

- Change the angle of nail entry.
- Use thinner cleats or nails (18-20 gauge).
- Use an over-size base or foot plate to distribute the nailing force.
- Pre-drilling pilot holes and hand nailing may be required.
- As a last resort, use glue-down method instead, especially on thinner floors.

Fastening Failure

Fastening failure is NOT a flooring product defect. Inappropriate fastener may cause mechanical failure. It will fail to hold the floor attached to the subfloor. Do not mix fasteners of different length or gauge. Always check with fastener manufacturer to insure the correct method and size fastener are being used to install the floor to the existing floor subfloor.

Bond Failure

Bond failure is NOT a flooring product defect. Most installation failures, including bond failure, result from jobsite moisture. Do not unpack or deliver flooring to the jobsite until moisture problems are corrected. Read adhesive manufacturer's instruction carefully. Certain wood flooring adhesives may have special requirements and limitations of use. Some existing floor may not be acceptable. Not following the adhesive manufacturer's recommendations can lead to installation failure or product damage and will void your warranty.

Glue Spots on Face of Finished Floor

Adhesive can damage the floor's finish, especially when it has dried. It is extremely important to take precautionary steps NOT to leave finger prints or footprints glue marks on the face of the board. Any glue that comes in contact with the face of the board should be removed immediately using adhesive remover formulated for the glue being used. Follow adhesive manufacturer's instruction on adhesive removal. Use clean towels, changing frequently to prevent haze and adhesive residue. If the spot removal damages the appearance of the boards, replace the board.

Helpful Pointers

General Tips

- Make sure your work area is well lit. Good visibility ensures that color is consistent and that visually defective planks are detected and removed.
- The preferred minimum length of the first and last plank is 12".
- Leave 1/2" expansion gap around perimeters, under doors and around vertical objects, including permanent or fixed cabinetry.
- Using a shorter piece at undercut door jams will help when fitting flooring in place.

Nail-Down Installation Tips

- Make sure power cleats are approved for use in OSB if plywood is not used as a substrate.
- First and last rows require hand nailing because the pneumatic or power-nailer cannot be used safely.
- First and last rows require pre-drilling through the face, nailing with 8d nails, countersinking the nails and using matching color putty to fill holes.
- Until power nailer can be used safely, additional rows may require pre-drilling through the tongue; blind nailing it with 8d nails; countersinking the nails.
- Use a wood spline or slip tongue whenever a change of board direction is needed. Splines should be glued to the groove and nailed into place.
- If the last row is less than 1" wide, it should first be glued to the previous uninstalled row and the two joined unit should be face-nailed as one.
- Occasionally, a piece may be slightly bowed. Nail one end first, then use the pry bar to push the other end in place, nailing as you go.

Glue-Down Installation Tips

- ALWAYS REFER TO THE SPECIFIC INSTRUCTIONS ON THE FLOORING ADHESIVE LABEL. The information given here is for typical installation. Adjust it according to adhesive manufacturer's instruction.
- Dry-lay means the glue must set before placing floor planks in it. Wet-lay means the glue does not need to set before placing floor on it.
- Use trowel as specified by adhesive manufacturer.
- Continuously check the transfer of adhesive THROUGHOUT the installation process. If the adhesive no longer transfers to the back of the flooring material, it must be removed, and new adhesive applied.
- Work your way out of the room.
- After the installation is completed, keep the floor free from daily foot traffic for a minimum of 24 hours to allow adhesive to properly cure.

Cutting the Last Row to Width

- Most often the entire length of the last row will need to be cut so that it is narrow enough to fit the remaining space.
- Measure the distance between the floor face edge (exclude the tongue) to the wall. Subtract 1/2" from this measurement for expansion gap. Draw a line. Cut through the line. Discard the excess piece. Proceed with installation.

Pre-Install Activities

- Lay out the board from several cartons. Rack the boards to give you the appearance you want. Colors and shades should be mixed up evenly. End joints should be staggered; minimum ends stagger is 6" and varied.

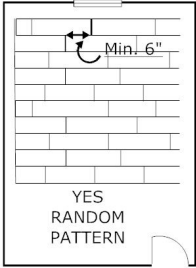

- Inspect plank quality and grading. If flooring is defective, contact dealer or the store immediately and discontinue installation.
- Lay out trim moldings in advance and find planks or strips whose shade closely coordinates the floor. Set these aside for future use.
- Remove existing base, shoe molding or threshold carefully. They can be used to cover the 1/2" expansion gap left around the edge of the room.
- Subfloors should be clean prior to the floor installation.
- Undercut doors and casings using a handsaw laid flat on a piece of scrap flooring. This will eliminate difficult scribe cuts.
- Install the underlayment (if used) according to underlayment manufacture instructions.
- Always use protective foot/pad and proper height adapter plate on the fastening machine to prevent face damage, mallet damage, and edge bruising.
- TEST FIRE THE POWER NAILER ON SACRIFICIAL FLOOR PLANK ONTO A BOARD. CHECK NAIL PENETRATION. CHECK FOR IMPACT DAMAGE ON FLOOR FACE. CHECK FOR SPLITTING TONGUE.

Nail Down Installation

For Products 6 inches and wider:

In addition to the use of mechanical fasteners, assisted glue applications should be used. The glue should be a premium grade urethane construction adhesive applied in a serpentine pattern to the back of each board. Then follow the recommended fastening pattern.

Step 1 – Establish a Starting Line

- Lay out the direction of the floor. Install flooring perpendicular to joists. If possible, install the flooring perpendicular to the joists
- Select a straight starter wall.
- Mark the starting line using a chalk line or a string between two nails. This distance between the wall and the line should equal the face width of floor plank plus 3/4" (1/2" expansion gap plus 1/4" tongue width = 3/4"). Do not include the width of the tongue. This will result in 1/2" gap between flooring and the wall.

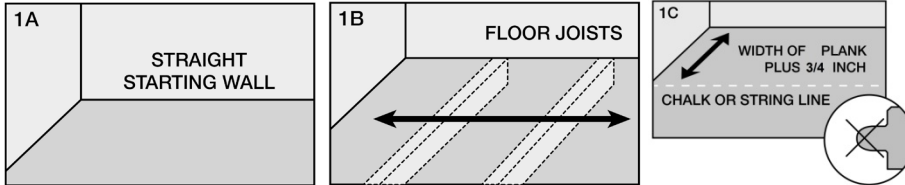

Step 2 – Install the First and Second Rows

- Lay the first plank behind the line with the tongue facing the center or the room. Position the edge of the tongue on the line. Leave a 1/2" gap between flooring end and the wall. There should not be a tongue between the floor planks and the wall.
- On the groove side, pre-drill and face nail.
- On the tongue side, pre-drill at 45° angle and hand blind nail through the nailing "pocket" on top of the tongue.
- Counter sink the nails with nail set. Repeat same method to complete first row.
- On the second row, remember to stagger the end joints. *If you can safely use your power nailer use it.* If not: pre-drill the tongue at 45° angle and repeat hand blind nailing with finish nails as above.

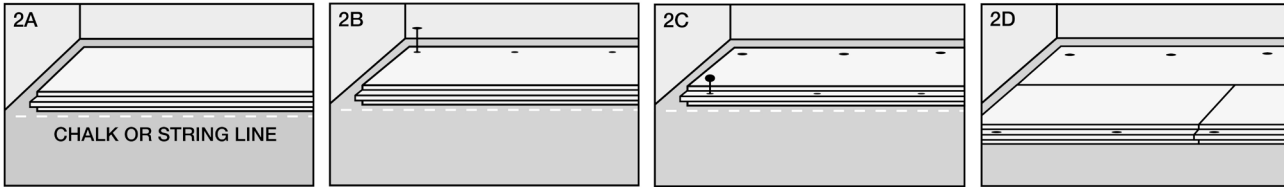

Step 3 – Install the Remaining Rows

- If the pneumatic or power nailer cannot be used on the next row, repeat the second-row installation method until the power nailer can be used.
- When the pneumatic nailer can be used, blind nail the rows on the tongue side. Place nails at the same intervals as the previous rows.
- Remember to maintain minimum 6" end joints stagger between rows.

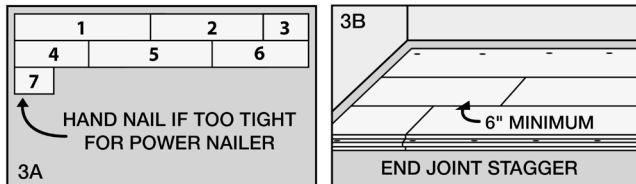

Step 4 – Install the Last Row

- Use the pull bar to draw the last row to fit tightly to the previous row.
- Face-nail the last row on the tongue side.
- If the last row is less than 1" wide, it should first be glued to the previous uninstalled row and the two joined unit should be face nailed as one.

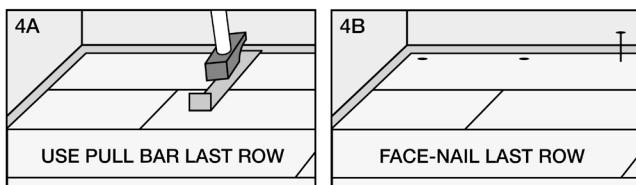

Glue-Down Installation

PLEASE NOTE:

ANY GLUE WHICH GETS ONTO THE SURFACE OF THE FLOOR MUST BE REMOVED IMMEDIATELY WITH ADHESIVE REMOVER.

Step 1 – Establish a Starting Line

- Lay out the direction of the floor. If possible, install the flooring perpendicular to the joists
- Select a straight starter wall.
- Mark the starting line using a chalk line or a string between two nails. This distance between the wall and the line should equal the face width of 2 floor planks plus 3/4" (1/2" expansion gap plus 1/4" tongue width = 3/4"). Do not include the width of the tongue.
- Securing a straight edge on the side away from the starting wall is recommended to ensure straight alignment of the starter rows. Install a straight edge.

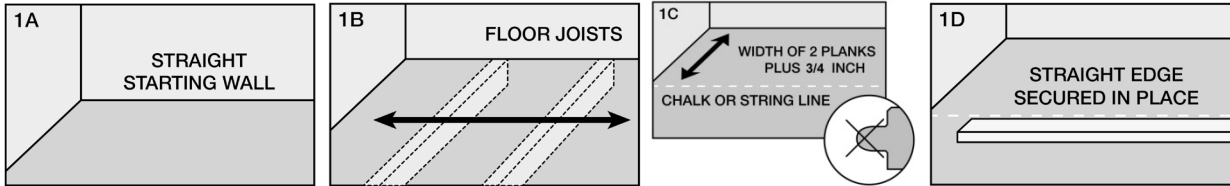

Step 2 – Spreading the Glue

- Spread the glue from the straight edge or chalk line out, in the direction of the starting wall. Spread only enough glue to install what can be set within 45 minutes (15 minutes of OPEN TIME and an additional 30 minutes for actual installation). Usually about two rows width coverage. Different manufacturer may require different open time and set time.
- You will repeat the same procedure with each succeeding row.

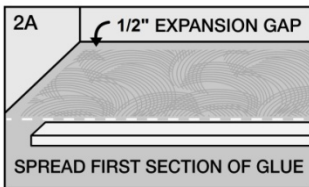

Step 3 – Install the Starter Rows (first two rows)

- Installation begins from the straight edge with tongue facing away from the wall. Allow expansion gap between the wall and the end of the board.
- Install the row in front of it. Use 75 lbs. roller or weigh them down while the glue sets. Allow the glue to set.
- Remove the straight edge.

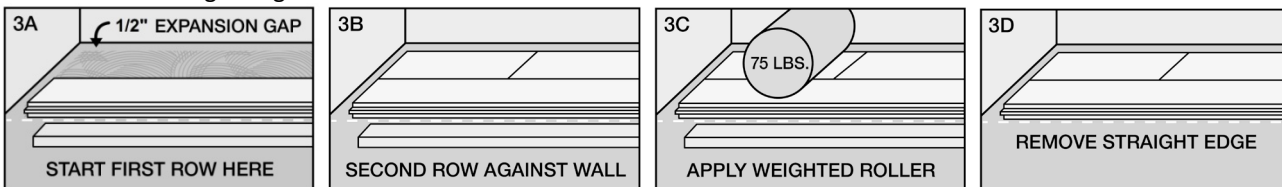

Step 4 – Install the Remaining Rows

- Spread another section of glue. Never spread more that can be covered before the adhesive is set. If adhesive is set and will not transfer to the back of the plank, scrape off the adhesive and apply fresh adhesive.
- Continue to install the next rows. Make sure there is a random staggering at the end joints of at least 6" apart.
- Be attentive to staggering the ends of the boards correctly in adjacent rows to avoid clustering end joints.
- Maintain a 1/2" expansion gap around the perimeter of the room.
- Make sure that there is 100% contact between the solid wood floor and the adhesive.
- Any excess glue which seeps onto the surface of the floor must be removed immediately with adhesive remover.
- The glue should not be applied in the groove or the tongue of the flooring.
- Use a tapping block to ensure good connection between the tongue and groove. Carefully, tap the planks together until the tongue and groove "snap" into place.
- Use a clean, smooth, 75-pound roller to roll the flooring immediately after installation and after every 150 square foot interval during the installation to insure proper adhesive transfer.
- Flooring straps can be used to pull boards together and hold them in place while the glue dries. After installation, strap should be kept in place for 24 hours.
- After the installation is completed, keep the floor free from foot traffic for a minimum of 24 hours to allow adhesive to properly set.

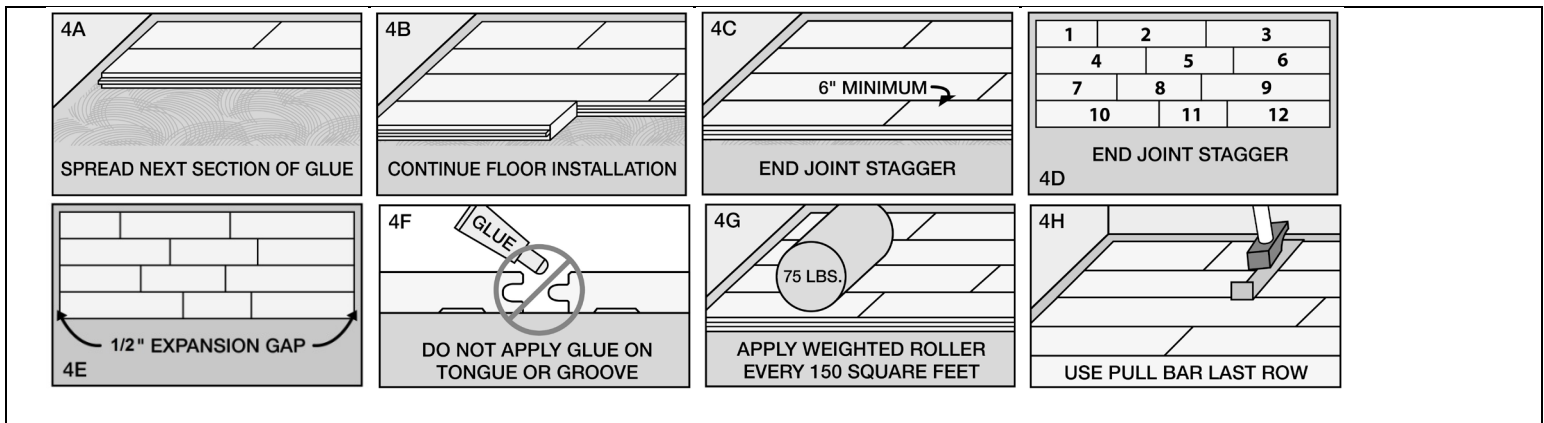

Floating Installation (For Residential Installation only)

Step 1 – How to Apply the Glue

- Use adhesive or glue which is formulated for tongue and groove floating installation. Refer to glue manufacturer’s information on applicability to engineered hardwood floating installation.
- The glue must be placed along the topside of the groove the full length of the grooved side and end. This can be accomplished by inverting the plank and applying a bead of glue (3/32”) to the topside of the groove (side of the groove nearest the face of the plank).
- When the plank is turned back over, the glue will flow down the back of the groove allowing total coverage. Apply only a 3/32” bead of glue; if the groove is completely filled, it will be difficult to close the seam not allowing a tight fit.

Step 2 – Starting Line

- Lay out the direction of the floor. If possible, install the flooring perpendicular to the joists
- Select a straight starter wall.
- Mark the starting line using a chalk line or a string between two nails. This distance between the wall and the line should equal the face width of 2 floor planks plus 3/4” (1/2” expansion gap plus 1/4” tongue width = 3/4”). Do not include the width of the tongue.

Step 3 – Installing the First Row

- The planks are laid with the groove side facing the wall. The first row starts with a full-length board. Depending on tongue and groove orientation, work can begin at either corner of the floor with groove side facing the walls.
- Ensure there is 1/2” expansion gap by following the starting line or using spacers or board.
- Plank 2 end groove is connected to the end tongue of Plank 1. Lay the rest, plank after plank, in this manner until you have completed the first row.

Step 4 – Installing Rows 2 and 3

- After setting the first row and making sure you are against a firm starting point, layout two more rows and install them.
- The three rows of flooring are held in place with flooring straps.
- These three rows must be straight, square and in rack because they establish the alignment of the rest of the floor.
- After putting these three rows together allow the glue to set (15 to 45 minutes or per glue manufacturer’s information) before proceeding with the rest of the rows installation.
- With the tongue facing out, the planks can be tapped together with a tapping block on the tongue to make a snug fit.

Step 5 – Installing Rest of Rows

- Continue installing rows. After installing 8 or 10 rows of flooring, stand back and check for crowning or heaving due to tension strapping or any damage caused by improper tapping.
- Use a pull bar on the last row to ensure snug and tight joint.

Finishing Touches

- Clean the floor.
- Use matching putty where necessary
- Install or reinstall all wall trim pieces. Nail them through the wall, but not to the subfloor to avoid restricting the expansion gap.
- Install transition trim pieces. Nail them to the subfloor, not the flooring.
- At doorways, transitions should be used to protect the edges of the floor and to provide a decorative transition from one floor type to another.
- If the floor is to be covered, use a breathable material such as cardboard. Do not cover with plastic.

Accessories

Pictures are for general illustrative purposes only. Actual products may differ from picture.

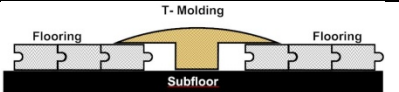
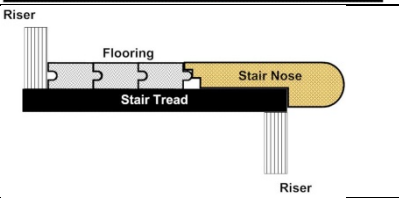
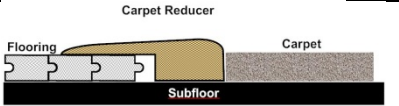
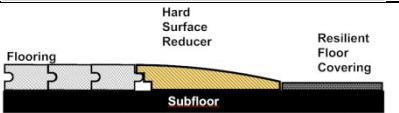
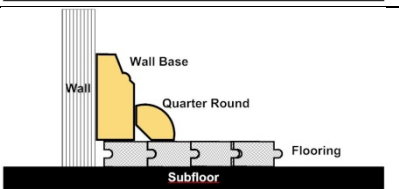
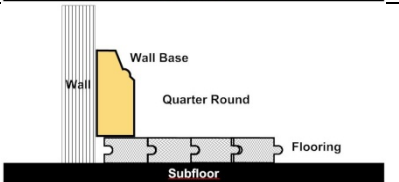
 <p>The diagram shows a cross-section of a subfloor with two pieces of flooring on either side. A T-shaped molding is placed over the joint between the two flooring pieces, bridging the gap.</p>	<p>T-Molding is used to create a transition between floor coverings of similar heights or to cover an expansion gap.</p>
 <p>The diagram shows a cross-section of a stair tread and riser. A curved, rounded piece of material, the stair nose, is attached to the top edge of the stair tread, extending over the edge of the tread.</p>	<p>Stair Nose is used in conjunction with flooring installed on stair steps or finished edge of a higher-level floor like in a sunken living room.</p>
 <p>The diagram shows a cross-section of a subfloor with a piece of flooring on the left and a piece of carpet on the right. A wedge-shaped reducer strip is placed over the joint, tapering from the flooring side to the carpet side.</p>	<p>Carpet Reducer (also called Baby Threshold or End Cap) is used to transition floor coverings of differing heights. This reducer strip is also commonly used to border a fireplace, sliding glass door and other exterior door jambs.</p>
 <p>The diagram shows a cross-section of a subfloor with a piece of flooring on the left and a piece of resilient floor covering on the right. A wedge-shaped reducer strip is placed over the joint, tapering from the flooring side to the resilient floor covering side.</p>	<p>Hard Surface Reducer is used to transition to another hard surface flooring of different heights such as tile, vinyl, concrete.</p>
 <p>The diagram shows a cross-section of a wall and a subfloor. A wall base is attached to the wall. A quarter round molding is placed over the joint between the wall base and the flooring, creating a smooth transition.</p>	<p>Quarter Round is used to cover the expansion space between the Wall Base and your flooring. It can also be used them to make smooth transitions between the floor and cabinetry. It can be used with or without Wall Base molding.</p>
 <p>The diagram shows a cross-section of a wall and a subfloor. A wall base is attached to the wall, extending down to the subfloor. The flooring is installed on the subfloor, and the wall base covers the gap between the wall and the subfloor.</p>	<p>Wall Base is used to give a finished look at the base of the walls. It can be used with or without Quarter Round.</p>

Technical Support

For installation information and technical questions not covered in this installation guide, please contact our Technical Support Representative by calling the toll-free number below.

Toll Free Number: 877-630-1800 or 877-960-8001

Warranty

This flooring product comes with a Home Legend Limited Wear Warranty. The warranty applies to original purchaser of the flooring. It warrants the original purchaser that the finish surface will not wear through for duration of the stated warranty from the date of purchase. Please contact our Customer Service Representative by calling our toll-free number 877-630-1800 or 877-960-8001 or send in the warranty registration below for a written copy which provides detail terms of coverage and limitations. You may also email your request to claims@homelegend.com.

WARRANTY REGISTRATION

UPON RECEIPT OF THIS REGISTRATION FORM AND COPY OF RECEIPT, WE WILL SEND YOU A WRITTEN WARRANTY DOCUMENT. SEND ONE COMPLETED FORM ALONG WITH A COPY OF PROOF OF PURCHASE TO:

HOME LEGEND, LLC
WARRANTY REGISTRATION
P.O. BOX 887
ADAIRSVILLE, GA 30103

Customer Name	
Customer Address	
City, State, ZIP Code	
Phone/E-mail	
Product Model Number	
Product Description	
Date Purchase	
Retailer Name	
Retailer Address	
City, State, ZIP Code	
Installer	